

DS-2TD2636-10 Thermal & Optical Network Bullet Camera

DeepinView



Introduction

Hikvision DS-2TD2636-10 Thermal Bi-spectrum Network Bullet Camera is applied to perimeter defense and fire-prevention purposes in critical infrastructures such as: airport, railway, prison, power station, 4S stores, and so on. The pre-alarm system helps you discover unexpected events immediately and protects you from property loss.

Smart Function (Thermal Imaging)

- Leading image processing technology: Adaptive AGC, DDE, 3D DNR, NETD less than 40 mk (0.04°C), F#=1.0
- Powerful behavior analysis function, based on deep learning algorithm: Line crossing, Intrusion, Region Entrance & Exit
- Reliable temperature exception alarm function
- Advanced fire detection algorithm
- Bi-spectrum image fusion, picture in picture preview

Thermal Imaging Module Function

- 384 × 288 resolution sensor, high sensitivity sensor, support contrast adjustment
- Shutter adjustment in various modes
- 3D DNR, 15 palettes of color adjustable, image detail enhancement
- Mirror image, digital zoom ×2, ×4, ×8, and local output



Specifications

Thermal Module	
Image Sensor	Vanadium Oxide Uncooled Focal Plane Arrays
Max. Resolution	384 × 288
Pixel Interval	17μm
Response Waveband	8μm to 14μm
NETD	less than 40 mk (0.04°C), F#=1.0
Lens (Focal Length)	10 mm
MRAD	1.70 mrad
Field of View	37.7°× 28.7° (H × V)
Min. Focusing Distance	1.0 m
Aperture	F1.0
Optical Module	
Max. Image Resolution	1920 × 1080
Image Sensor	1/2.8" Progressive Scan CMOS
Min. Illumination	Color: 0.002 Lux @(F1.5,AGC ON), B/W: 0.0002 Lux @(F1.5, AGC ON)
Shutter Speed	1s to 1/100,000s
Lens (Focal Length)	6 mm
Field of View	52.8° × 30.0°(H × V)
WDR	Digital WDR
Day & Night	IR cut filter with auto switch
Image Function	
Bi-spectrum Image Fusion	Fusion view of thermal view and overlaid details of the optical channel
Picture in Picture	Combines details of thermal and optical image PIP, overlay thermal image on optical image
Smart Function	
VCA (Video Content Analysis)	4 VCA rule types (Line Crossing, Intrusion, Region Entrance, and Region Exiting), up to 8 VCA rules.
Temperature Measurement	3 temperature measurement rule types, 21 rules (10 points, 10 regions, and 1 line).
Temperature Range	-20 °C to +150 °C (-4 °F to +302°F)
Temperature Accuracy	± 8 °C (± 14.4 °F)
Fire detection	Dynamic fire point detection, up to 10 fire points detectable.
Infrared	
IR Distance	Up to 40 m
IR Intensity and Angle	Automatically adjusted

Network	
Main Stream	Visible Light: 50Hz: 25fps (1920 × 1080), 25fps (1280 × 960), 25fps (1280 × 720) Visible Light: 60Hz: 30fps (1920 × 1080), 30fps (1280 × 960), 30fps (1280 × 720) Thermal: 50fps (384 × 288)
Sub Stream	Visible Light: 50Hz: 25fps (704 × 576), 25fps (352 × 288), 25fps (176 × 144) Visible Light: 60Hz: 30fps (704 × 480), 30fps (352 × 240), 30fps (176 × 120) Thermal: 50fps (384 × 288)
Video Compression	H.265/H.264/MJPEG, H.265+/H.264+ encoding with Baseline/Main/High Profile
Audio Compression	G.711u/G.711a/G.722.1/MP2L2/G.726/PCM
Protocols	IPv4/IPv6, HTTP, HTTPS, 802.1x, Qos, FTP, SMTP, UPnP, SNMP, DNS, DDNS, NTP, RTSP, RTCP, RTP, TCP, UDP, IGMP, ICMP, DHCP, PPPoE
Simultaneous Live View	Up to 20
User/Host level	Up to 32 users, 3 levels: Administrator, Operator, User
Security Measures	User authentication (ID and PW), MAC address binding, HTTPS encryption, IEEE 802.1x access control, IP address filtering
Integration	
Alarm Input	2-ch inputs (0-5vDC)
Alarm Output	2-ch relay outputs, alarm response actions configurable
Alarm Action	SD recording/Relay output/Smart capture/FTP upload/Email linkage
Audio Input	1 3.5mm Mic in/Line in interface. Line input: 2-2.4V[p-p], output impedance:1KΩ±10%
Audio Output	Linear Level; Impedance: 600Ω
Reset	1 Reset Button
Ethernet	1 RJ45 10M/100M Self-adaptive Ethernet interface
SD Memory Card	Built-in Micro SD card slot, support Micro SD/SDHC/SDXC card (up to 128G), support manual/alarm recording
Analog Video Output	1.0V [p-p]/75Ω, PAL/NTSC/BNC
Application Programming	Open-ended API, support ISAPI, HIKVISION SDK and third-party management platform
Client	iVMS-4200
Web Browser	IE7+, Chrome18+, Firefox5.0+, Safari5.02+
General	
Menu language	English
Power	24 VAC± 25%, 12 VDC± 20%, two-core terminal block PoE (802.3at, class 4)
Power Consumption	24 VAC± 25%: 0.84 A, 12 VDC ± 20%: 1.6 A, max. 10W (20 W with De-icing Heater On), PoE (802.3at, class 4): 42.5 V to 57 V, 0.35 A to 0.47 A
Working Temperature/Humidity	-40 °C to 60 °C (-40 °F to 140 °F), 90% or less
Protection Level	IP66 Standard TVS 6000V Lightning protection, surge protection, voltage transient protection
Dimensions	314 mm × 104 mm × 104 mm (12.36 " × 4.09" × 4.09 ")
Weight	Approx. 1.55Kg (3.42lb)

Detection Range Table

* The table is only for reference, the performance may vary from camera to camera.

Smart functions Range

Different targets trigger the VCA events within different range limits.

VCA Range (Vehicles: 1.4×4.0m)	VCA Range (Humans: 1.8×0.5m)	Temperature Measurement (Object:2×2 m)	Temperature measurement (Object:1×1 m)	Fire Detection (Object:2×2 m)	Fire Detection (Object:1×1 m)
410 m	144 m	234 m	118 m	588 m	294 m

Wide Range Coverage

There is range limit for detecting, recognizing, and identifying human/vehicle targets.

Detection Range (Vehicles: 1.4×4.0m)	Detection Range (Humans: 1.8×0.5m)	Recognition Range (Vehicles: 1.4×4.0m)	Recognition Range (Humans: 1.8×0.5m)	Identification Range (Vehicles: 1.4×4.0m)	Identification Range (Humans: 1.8×0.5m)
902 m	294 m	225 m	74 m	113 m	37 m

Available Model

DS-2TD2636-10

Dimensions

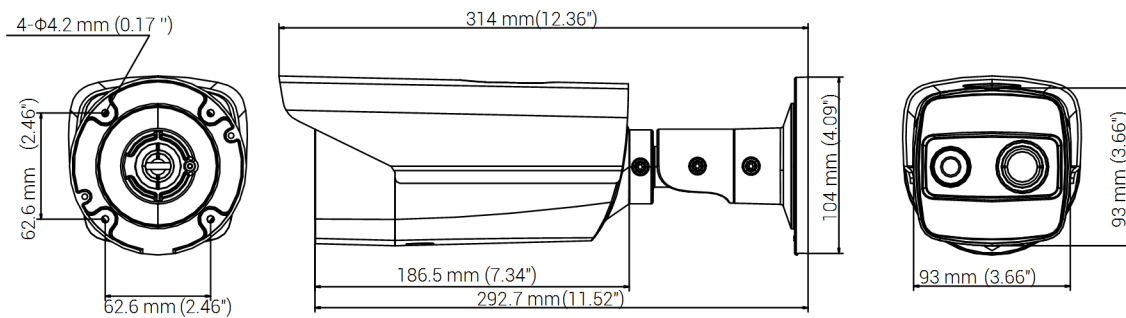

Distributed by

**HIKVISION®****Headquarters**

No.555 Qianmo Road, Binjiang District,
Hangzhou 310051, China
T +86-571-8807-5998
overseasbusiness@hikvision.com

Hikvision USA
T +1-909-895-0400
sales.usa@hikvision.com

Hikvision Australia
T +61-2-8599-4233
salesau@hikvision.com

Hikvision India
T +91-22-28469900
sales@pramahikvision.com

Hikvision Canada
T +1-866-200-6690
sales.canada@hikvision.com

Hikvision Thailand
T +662-275-9949
sales.thailand@hikvision.com

Hikvision Europe
T +31-23-5542770
sales.eu@hikvision.com

Hikvision Italy
T +39-0438-6902
info.it@hikvision.com

Hikvision Brazil
T +55 11 3318-0050
Latam.support@hikvision.com

Hikvision Turkey
T +90 (216)521 7070- 7074
sales.tr@hikvision.com

Hikvision Malaysia
T +601-7652-2413
sales.my@hikvision.com

Hikvision UK & Ireland
T +01628-902140
sales.uk@hikvision.com

Hikvision South Africa
Tel: +27 (10) 0351172
sale.africa@hikvision.com

Hikvision France
T +33(0)1-85-330-450
info.fr@hikvision.com

Hikvision Kazakhstan
T +7-727-9730667
nikia.panfilov@hikvision.ru

Hikvision Vietnam
T +84-974270888
sales.vt@hikvision.com

Hikvision UAE
T +971-4-4432090
salesme@hikvision.com

Hikvision Singapore
T +65-6684-4718
sg@hikvision.com

Hikvision Spain
T +34-91-737-16-55
info.es@hikvision.com

Hikvision Tashkent
T +99-87-1238-9438
uzb@hikvision.ru

Hikvision Hong Kong
T +852-2151-1761
info.hk@hikvision.com

Hikvision Russia
T +7-495-669-67-99
saleru@hikvision.com

Hikvision Korea
T +82-(0)31-731-8817
sales.korea@hikvision.com

Hikvision Poland
T +48-22-460-01-50
info.pl@hikvision.com

Hikvision Indonesia
T +62-21-2933759
Sales.Indonesia@hikvision.com

Hikvision Colombia
sales.colombia@hikvision.com